

R&S® CMX500

RADIO COMMUNICATION TESTER

Future-proof one-box solution for 5G NR testing



Product Brochure
Version 02.01

ROHDE & SCHWARZ

Make ideas real





CONTENTS

R&S®CMX500 – 5G NR test solution from the reliable partner

From a single source, made in Germany
▶ page 4

R&S®CMX500 – at a glance
▶ page 6

5G NR solutions from Rohde & Schwarz
▶ page 8

R&S®CMX500 – based on the one-platform strategy
▶ page 10

R&S®CMX500 – a true allrounder
▶ page 12

R&S®CMX500 highlights

R&S®CMsquares – the powerful control center
▶ page 14

R&D test suite with all utilities unified in one place
▶ page 16

Test sequence automation with R&S®CMsequencer
▶ page 18

XLAPI Python interface for writing repeatable routines
▶ page 19

Unique integrated solution for 5G end-to-end testing
▶ page 20

Application-centric signaling concept
▶ page 22

R&S®CMX500 use cases

RF testing
▶ page 25

5G application testing
▶ page 28

Carrier acceptance tests and certifications
▶ page 30

Additional information

Complementary products from Rohde & Schwarz
▶ page 32

Ordering information
▶ page 34

From presales to service. At your doorstep.
▶ page 35

Rohde & Schwarz headquarters in Munich, Germany.

FROM A SINGLE SOURCE, MADE IN GERMANY

As a world market and technology leader in all areas of RF and microwave test and measurement solutions, Rohde & Schwarz supports the entire mobile technology lifecycle for measurements in the lab, in production and in the field.

Rohde & Schwarz – more than 80 years of quality, precision and innovation in all RF test and measurement fields.

Every industrial sector needs electronics. Test and measurement solutions from Rohde & Schwarz are there every step of the way, including R&D, quality assurance, manufacturing and service. Our portfolio covers all types of RF T&M equipment and systems as well as complementary products.

Expertise in radiocommunications testing

Ever since the first generation of mobile communications was launched, Rohde & Schwarz has offered test and measurement solutions for all applications along the entire value chain. Our all-in-one R&S®CMW platform set standards in fourth generation cellular technologies in both signaling and non-signalling applications. We are now building on this expertise for the fifth generation of cellular technologies with the R&S®CMX500 and R&S®CMP200 radio communication testers.

Evolution of cellular technologies

Rohde & Schwarz has been a part of the technology right from the start and played an important role in shaping it.

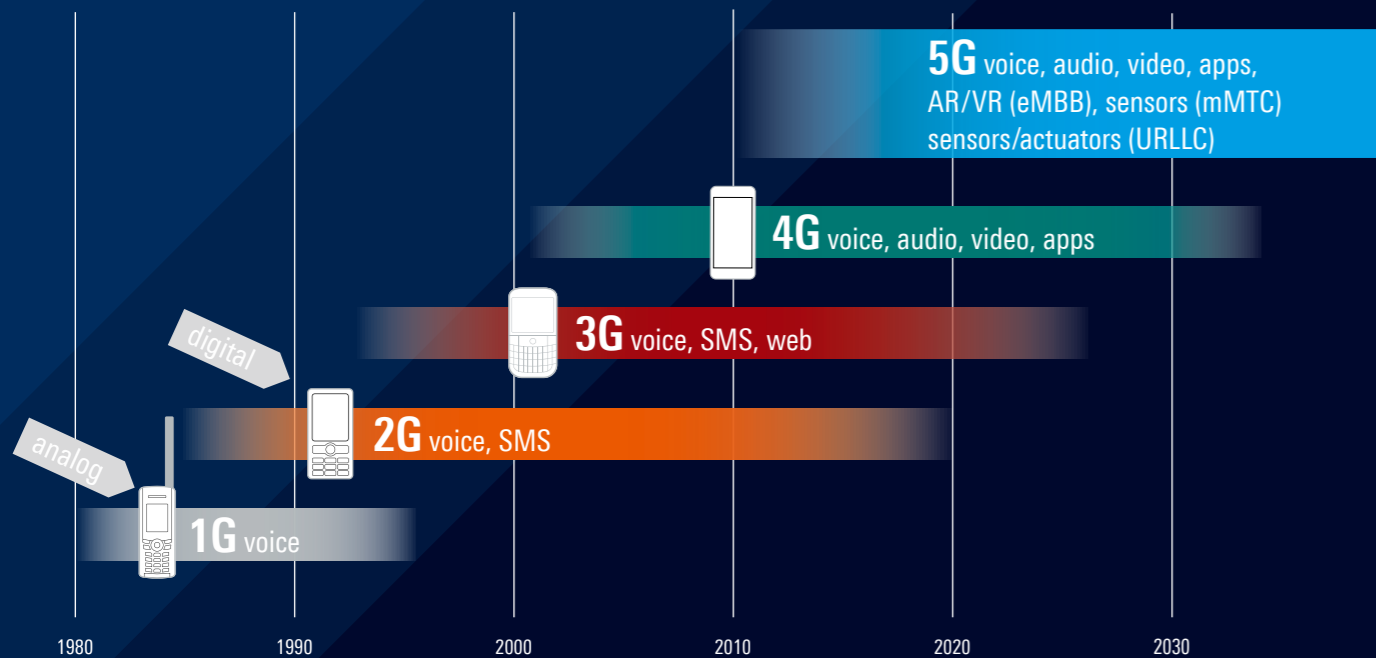

5G challenges

5G is changing the way we communicate and has challenging demands. 5G introduces a paradigm shift towards user and application focused technology frameworks to flexibly support three important use case families:

- ▶ Enhanced mobile broadband (eMBB)
- ▶ Massive machine type communications (mMTC)
- ▶ Ultra-reliable, low latency communications (URLLC)

Rohde & Schwarz 5G testing solutions

Your 5G NR test and measurement challenges – from components and chipsets to assembled user devices and base stations – motivate us to provide innovative solutions that help you succeed. Bring your products to market quickly and reliably with Rohde & Schwarz 5G testing solutions.

High-tech made in Germany

Rohde & Schwarz not only develops solutions but also manufactures the components for these solutions at the company's high-tech plants in Germany. Rohde & Schwarz combines innovation and in-house manufacturing depth. In contrast to other suppliers we offer all manufacturing processes, from electroplating and printed board assembly to microelectronics production, cable assembly and antenna production.

Rohde & Schwarz ...

- ... offers an overall solution from a single source with reliable accuracy and repeatability
- ... is a partner who takes responsibility for the entire system
- ... leadership in 5G technology results in a range of sophisticated products
- ... offers one-stop-shopping
- ... has deep in-house know-how of all products, such as testers, shielding and accessories
- ... ensures optimum on-site support thanks to a worldwide network
- ... offers experienced worldwide service and maintenance from a single source



Rohde & Schwarz headquarters in Munich, Germany.



Manual component placement at the Rohde & Schwarz Memmingen plant, Germany.



Clean room at the Rohde & Schwarz Teisnach plant, Germany.



Antenna assembly at the Rohde & Schwarz Teisnach plant, Germany.

R&S®CMX500 – AT A GLANCE

The R&S®CMX500 radio communication tester is designed to cover all 5G signaling test applications and to support E2E data rates up to 20 Gbps.



R&S®CMX500 radio communication tester.

Reliable

The hardware and software of the R&S®CMX500 radio communication tester can handle all signaling use cases for mobile communications devices, from early R&D design to final integration, verification and performance tests, final product validation in a test house, quality assurance and repair.

Fully integrated

The modular hardware architecture can be configured for basic use cases such as RF parameter measurements, measurements under fading conditions and performance measurements with maximum data rates. Users can access all signaling events and logs at any time.

The R&S®CMX500 no longer makes the traditional separation between RF tester, application tester and protocol tester. It is a signaling tester with seamless transition between all use cases required for bringing a mobile cellular device from basic design to production. Previous testers had dedicated instruments for each stage.

Scalable architecture

The R&S®CMX500 hardware modules are designed for versatile tasks. Users have enormous flexibility since they can perform different measurement tasks with the same test station, because it has no boards dedicated to specific measurement tasks. A basic configuration is all that is needed for signaling, fading and/or data E2E applications.

Future-proof

The R&S®CMX500 is designed to meet all test requirements that may occur over the entire product lifecycle of a mobile communications device. Rohde & Schwarz permanently implements all new standardization and test house requirements. The seven height units of the R&S®CMX500 include plenty of space for future extension modules.

KEY FEATURES

- 1 RELIABLE**
R&S®CMsquares – one user interface to manage and control RF, protocol and application testing
- 2 FULLY INTEGRATED**
Split concept with IF tester, mmWave remote radio head and shielding cube
- 3 SCALABLE ARCHITECTURE**
For different use cases and performance requirements
- 4 FUTURE-PROOF**
Allows extensions for future use cases and requirements

5G NR SOLUTIONS FROM ROHDE & SCHWARZ

5G NR challenges require high flexibility, end-to-end data testing solutions and reliable measurement methods. As a long-term partner to the mobile communications industry, Rohde & Schwarz offers a comprehensive portfolio of innovative 5G NR test solutions.

5G offers mobile network operators additional data services for transmission rates up to 20 Gbit/s in existing and additional frequency ranges and with higher bandwidths. To enable developers to test their mobile devices in 5G NR non-standalone and stand-alone mode in line with 3GPP specifications, test solutions must work seamlessly in both LTE and 5G NR networks.







5G signaling solutions

The R&S®CMX500 radio communication tester adds 5G NR signaling to existing LTE test and measurement solutions. Users with an R&S®CMW500 or R&S®CMWflexx test system for LTE and legacy measurements can continue using it and simply add an R&S®CMX500 as an extension box for 5G NR signaling tests. This makes it possible to test 5G NR use cases in non-standalone (NSA) and standalone (SA) mode in FR1 and FR2 in line with 3GPP requirements. An R&S®CMX500 radio communication tester plus remote radio head (e.g. the R&S®CMXHEAD30) and a shielded environment (e.g. the R&S®CMQ500 shielding cube) is all that is needed for pure 5G NR FR2 test environments.

5G non-signaling solutions

Rohde & Schwarz offers the R&S®CMPO for 5G NR FR2 testing (mmWave). The R&S®CMPO is a compact solution that combines the R&S®CMP200 radio communication tester with the R&S®CMPHEAD30 remote radio head (RRH) and the R&S®CMQ200 shielding cube. Together they form an easy-to-use, cutting-edge test solution with a wide variety of combination options. The FR1 sub6 solution consists of the well-known R&S®CMW100 communications manufacturing test set and measurement software (see R&S®CMPO product brochure, PD 3609.3742.12).

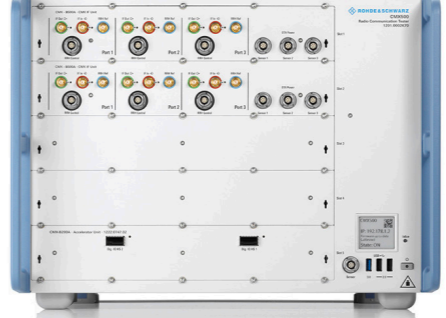
ROHDE & SCHWARZ RADIO COMMUNICATION TESTER PORTFOLIO

	LTE Advanced (plus legacy) 5G NR sub6	5G NR mmWave (plus 1F)
Non-signaling (RF analyzer and generator)	<p>LTE))) ((((5G)))</p>  <p>R&S®CMW100 communications manufacturing test set Sub6 GHz (FR1) RF tester for production lines</p>	<p>R&S®CMPO compact solution for 5G mmWave RF testing 5G mmWave RF parametric testing in production lines</p>  <p>R&S®CMP200 radio communication tester Non-signaling testing solution</p>  <p>R&S®CMPHEAD30 remote radio head Generation and analysis of RF frequencies > 20 GHz</p>  <p>R&S®CMQ200 shielding cube Compact shielding solution</p>
	<p>LTE)))</p>  <p>R&S®CMW500 wideband radio communication tester Universal test platform for RF integration and protocol development</p>	<p>R&S®CMX500 radio communication tester Efficient solution for 5G NR signaling tests</p>  <p>R&S®CMXHEAD30 remote radio head Up- and downconverter for 5G FR2 frequencies</p>  <p>R&S®CMQ500 shielding cube Compact shielding solution</p>
Signaling (network emulation)		

R&S®CMX500 – BASED ON THE ONE-PLATFORM STRATEGY

As with the R&S®CMW LTE platform, Rohde & Schwarz sticks to its proven one-platform strategy for 5G NR. The R&S®CMX500 and R&S®CMP200 both use this strategy.

FULLY INTEGRATED



BEST REPRODUCIBILITY
AND STABILITY



FUTURE-PROOF



DEVICES BASED ON THE ONE-PLATFORM STRATEGY

Signaling
sub6 + IF + mmWave



R&S®CMXHEAD30 remote radio head
R&S®CMX500 radio communication tester

TECHNOLOGY REUSE

- ▶ Same test concept
- ▶ Result traceability
- ▶ Synergy effects

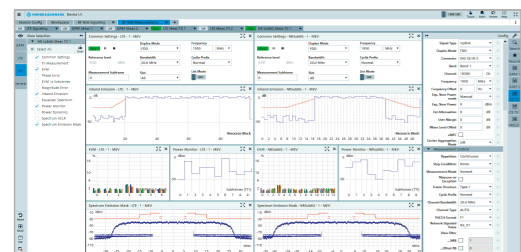

R&S®CMsquares test software

Non-signaling
IF + mmWave

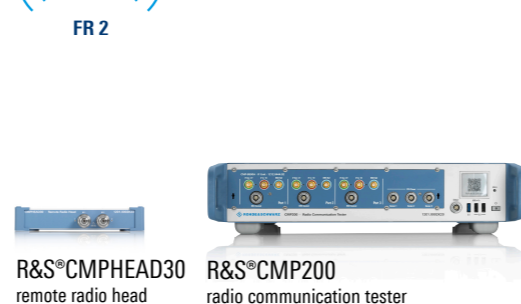

R&S®CMPHEAD30 remote radio head
R&S®CMP200 radio communication tester

IDENTICAL MEASUREMENTS



R&S®CMsquares test software

Identical technology, hardware and software

The one-platform strategy uses the same technology, comparable hardware and identical software in all test solutions and test stages, making test results comparable. The different test configurations (signaling/non-signaling) must deliver reproducible and validated test results. Rohde & Schwarz fulfills this requirement.

Reliable and reproducible test results

The test results must provide conclusive information about DUT characteristics without – figuratively speaking – testing the test solution. Rohde & Schwarz systems deliver accurate and consistently reproducible test results.

The Rohde & Schwarz one-platform strategy makes sure that when mature products are ready for production, the R&S®CMP200 will provide the same results seen during R&D stages with the R&S®CMX500.

ONE HARDWARE

The same technology platform is used as hardware with state-of-the-art components for all 5G NR mobile radio testers. This ensures reproducibility, scalability for new requirements and state-of-the-art architecture for high speed measurements.

ONE

ONE SOFTWARE

To create identical measurement setups, the R&S®CMsquares software minimizes programming effort for test engineers. The same software is used in all 5G NR device testers.

R&S®CMX500 – A TRUE ALLROUNDER

The R&S®CMX500 is designed to match all test requirements that can occur over the entire product lifecycle of a mobile communications device.

5G NR TEST AND MEASUREMENT

Solutions for non-standalone (NSA) and standalone (SA) mode

E2E COMMUNICATIONS TESTING

User experience tests, including voice, video, IP data transfer and OTT

MEETING IoT CONNECTIVITY REQUIREMENTS

Efficient solutions for cellular technologies and WLAN, Bluetooth® LE, Zigbee

TX AND RX MEASUREMENTS

Automated solution for 3GPP/3GPP2 RF conformance measurements



LTE-WLAN TRAFFIC OFFLOADING

Video and E2E tests for rerouting traffic from LTE to WLAN and back

PRECONFORMANCE AND CONFORMANCE TESTING

GCF and PTCRB validated test cases complying with 3GPP and OMA standards for certification of wireless devices

INTER-RAT AND ROAMING SOLUTIONS

Simple device tests (from RF to protocol) when transitioning from one technology to another and roaming test simulations

PROTOCOL TESTING

For all OSI layers, including sample test scenarios

For the entire product lifecycle

A mobile communications device has many components that must be independently tested step-by-step on various interfaces in development, for components matching during integration or as a final device. The R&S®CMX500 and the R&S®CMW500 wideband radio communication tester can provide users with any possible test solution imaginable for the entire product lifecycle. Rohde & Schwarz provides the widest variety of signaling test solutions, with unrivaled interoperability of signaling and non-signaling solutions.

For all challenges

All mobile device testing challenges can be met with Rohde & Schwarz testing solutions. The R&S®CMW wideband radio communication tester is the world's most widely used test and measurement platform for development. The R&S®CMX500 radio communication tester enables further 5G NR extensions by adding new technology standards.

For all use cases

Covering all use cases for 5G NR device testing from chip development and module testing to device testing in regression stations, R&D or test labs, the R&S®CMX500 is the platform for signaling tests in the sub6 GHz (FR1) and mmWave (FR2) frequency bands. In non-standalone (NSA) mode, the R&S®CMW500 supports legacy technologies that use mixed operation with LTE. Combining these two testers creates a scalable solution and provides users with established and new test cases with built-in steps.

WIRELESS TECHNOLOGIES TESTING

	RF generator	RF analyzer	Network emulation	Protocol testing	E2E application testing	Fading support
Cellular technologies						
5G NR	•	•	•	•	•	•
LTE-A	•	•	•	•	•	•
WCDMA/HSPA+	•	•	•	•	•	•
GSM/GPRS/EGPRS	•	•	•	•	•	•
eMTC	•	•	•	•	•	
NB-IoT	•	•	•	•	•	•
C-V2X	•	•	•	•	• ¹⁾	
CDMA2000® 1xRTT, CDMA2000® 1xEV-DO	•	•	•	• (inter-RAT LTE)	•	•
Non-cellular technologies						
WLAN IEEE 802.11a/b/g/n/ac/ax	•	•	•	• (offloading use cases)	•	•
Bluetooth® (BR/EDR/LE)	•	•	•			
IEEE 802.15.4 (ZigBee)	•	•				

¹⁾ Requires additional external software from partner. The Bluetooth® word mark and logos are registered trademarks owned by Bluetooth SIG, Inc. and any use of such marks by Rohde & Schwarz is under license.

R&S®CMsquares – THE POWERFUL CONTROL CENTER

As a modern, web based user interface and data testing solution for all applications, R&S®CMsquares is the control center for all measurement tasks in the R&S®CMX500. R&S®CMsquares simplifies device test development with easy configuration including early prototyping, development, verification, RF testing, protocol verification and data application testing.

- ▶ Dashboard style, simple entry point for all users
- ▶ Use case selection (e.g. NSA mode)
- ▶ User defined squares
- ▶ Easy access to all types of applications: interactive mode, sequencer, installation manager

Common graphical user interface

All R&S®CMX500 services are integrated in R&S®CMsquares, the common graphical user interface. It has a dashboard where all types of applications can be accessed. This unique user interface is controlled via web GUI. The standardized GUI provides a unified user experience for all Rohde&Schwarz 5G radio communication testers. All measurements can be operated manually in the workspace or built as test sequences in the integrated R&S®CMsequencer graphical scripting interface. Test routines can be remotely controlled via XLAPI and SCPI interfaces.

Browser based test software solution

R&S®CMsquares is a unified test software solution with browser based user experience that combines all that is needed for 5G NR testing. It provides everything from test configuration, parameterization, measurements as well as test execution in a single dashboard style environment with quick access to various applications. A standardized GUI can control all new 5G radio communication testers.

The interactive callbox mode helps rapidly connect to a device under test, alter network parameters on the fly, analyze real-time RF TX/RX measurements and trace protocol stack messages on all protocol layers or generate statistics for data throughput testing with a variety of chart diagrams. It also has a sequencer mode to run preconfigured 5G NR test scripts or simply create 5G NR test scripts from scratch with a simple drag and drop. Ultimately, an interactive mode and a sequencer mode can run in parallel to provide the same test results.

Squares concept

With R&S®CMsquares, users can access measurement tasks in separate measurement squares. The DUT is always in focus with R&S®CMsquares. With this DUT-centric approach, it is very easy to keep an overview of even complex test scenarios, test environments and measurement tasks. The next change is just one click away.

R&S®CMsquares includes as many squares as needed: for measurements, graphical outputs and statistical views, network layout and configuration, RF connection, message analyzer, test sequencer, scripting – you name it. The R&S®CMsquares layout can be configured for your personal preferences at any time.

DUT-centric operating concept

5G is taking mobile communications by storm. But since most use cases expand on existing cellular technologies such as LTE, device testing has become even more complex and time-consuming. A simple and efficient solution is needed to keep the transition to 5G as smooth as possible. Rohde&Schwarz puts the DUT in the center of the test environment.

In the test environment, the DUT is placed in the center of the four squares. Simply configure your device and network parameters to create your preferred 5G network for non-standalone or standalone mode, data services for throughput tests, RF connector cabling of the device as well as required RF measurements.



Easy measurement setup with R&S®CMsquares; shown here: configuration of RF non-standalone measurements.

R&D TEST SUITE WITH ALL UTILITIES UNIFIED IN ONE PLACE

The R&S®CMsquares test software platform has an intuitive control architecture based on test environment, measurement workspace, sequencer and message analyzer.

TEST ENVIRONMENT

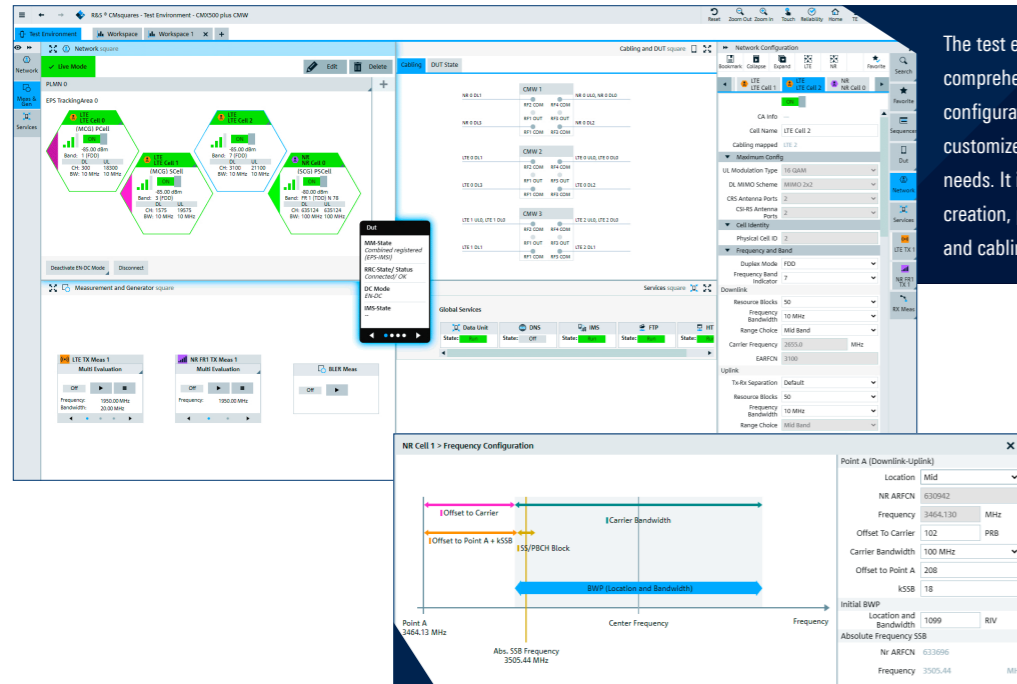

The test environment provides a comprehensive overview of all configurations and measurements with customized settings adapted to DUT needs. It is the control hub for network creation, parametrization, DUT control and cabling.

Utilities like the graphical frequency configuration dialog guide users to a valid 5G network configuration, no matter how complex 3GPP specifications may seem.

SEQUENCER

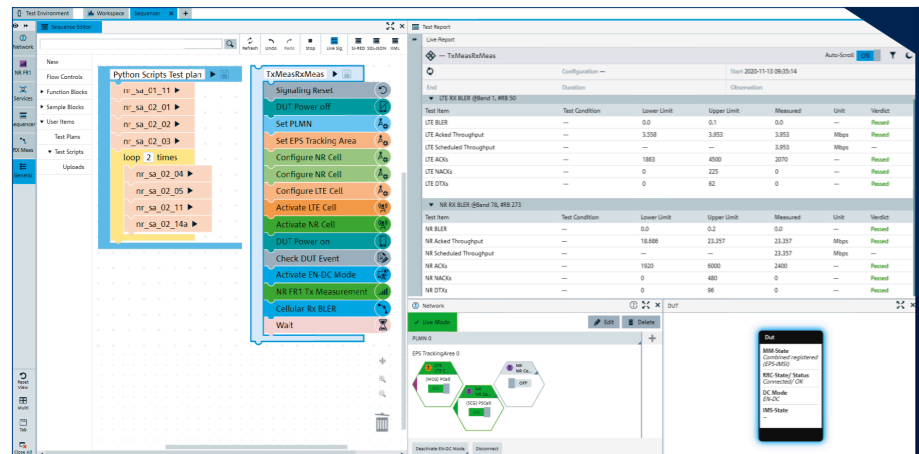

The R&S®CMsequencer features a unique graphical user interface and simplified workflows for creating and executing test scripts and complete test plans/campaigns. The built-in campaign manager offers all tools required for automated testing, parameterization and result reporting. Users are free to add other measurement squares in the sequencer for a seamless user experience with all kinds of RF, protocol and application tests.

MEASUREMENT WORKSPACE

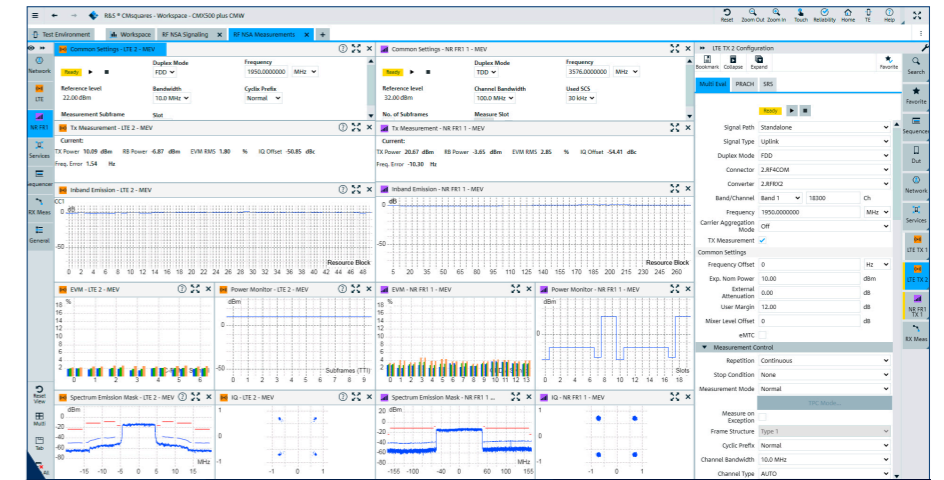

Measurements are performed in the workspace. It combines several squares for all technologies including LTE, FR1, FR2, TX and RX live measurements, data testing, monitoring, DUT control and throughput charts. The layout can be arranged to suit any use case. Users have immediate access to all signaling and measurement parameters within the workspace without leaving the measurement.

MESSAGE ANALYZER

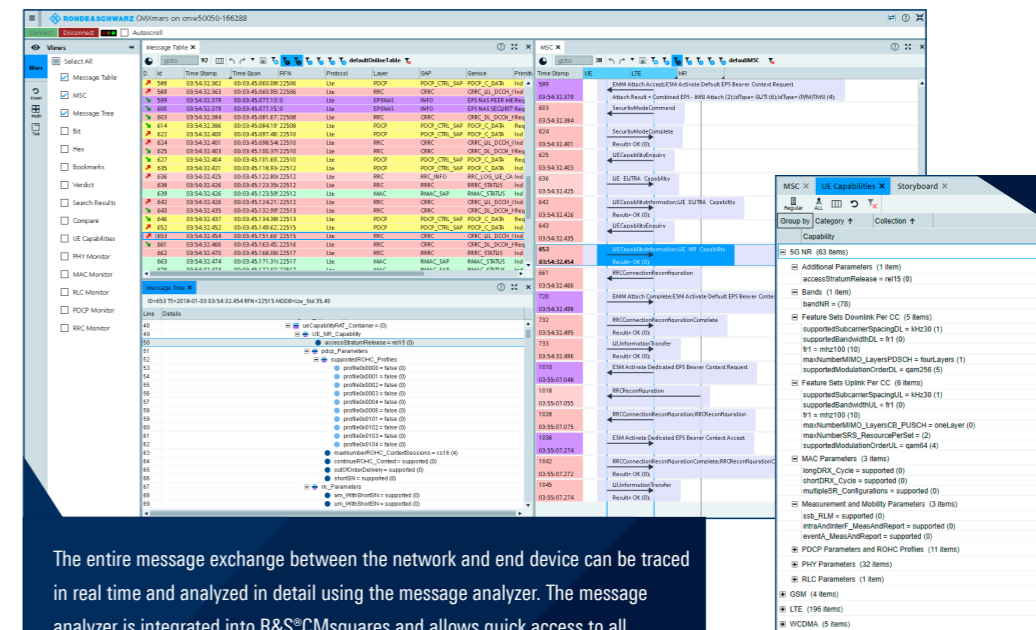

The entire message exchange between the network and end device can be traced in real time and analyzed in detail using the message analyzer. The message analyzer is integrated into R&S®CMsquares and allows quick access to all signaling communications layers between the DUT and the simulated network. Users can quickly narrow down DUTs protocol stack issues in the event of errors.

UE capabilities: The message analyzer combines several auxiliary tools to investigate the DUT protocol stack. Users get instant access to UE capabilities and band combinations reported by the DUT.

TEST SEQUENCE AUTOMATION WITH R&S®CMsequencer

The R&S®CMsequencer graphical scripting interface creates, configures and executes test scripts on the R&S®CMX500. The R&S®CMsequencer is part of R&S®CMsquares.

Having individual applications for specific testing areas is a thing of the past. The future is a more unified approach, where all necessary 5G test functions are available in a single graphical user interface. The R&S®CMsequencer provides users with a unique and intuitive way to create test sequences for a wide range of use cases, including 5G RF parametric testing, 3GPP RF testing, protocol verification and E2E IP testing. By working seamlessly with R&S®CMsquares interactive mode, R&S®CMsequencer makes it simple to create and execute test scripts and test plans in an automated environment. For a very straightforward process, users configure their tests by simply arranging color-coded functional blocks one after another. 5G testing has never been easier.

Key facts

- ▶ Automated environment to execute test scripts or test campaigns created with graphics or the python scripting interface
- ▶ 3GPP RF TX/RX tests in line with IEEE 38.521
- ▶ R&D RF signaling measurements including multi-evaluation measurements, BLER search, maximum power (both for FR1 and FR2)
- ▶ End-to-end throughput testing including IMS, VoLTE and VoNR
- ▶ 5G signaling feature capabilities (for e.g. carrier aggregation, mobility) with flexible configuration possibilities
- ▶ Automatic iteration over DUT-capable band combinations and result summary for each combination
- ▶ Online and offline measurement reports including charts and graphs in various data formats (e.g. csv, pdf)
- ▶ Seamless context switching to and from R&S®CMsquares interactive mode for unlimited testing flexibility

R&S®CMsequencer workspace within R&S®CMsquares web user interface.

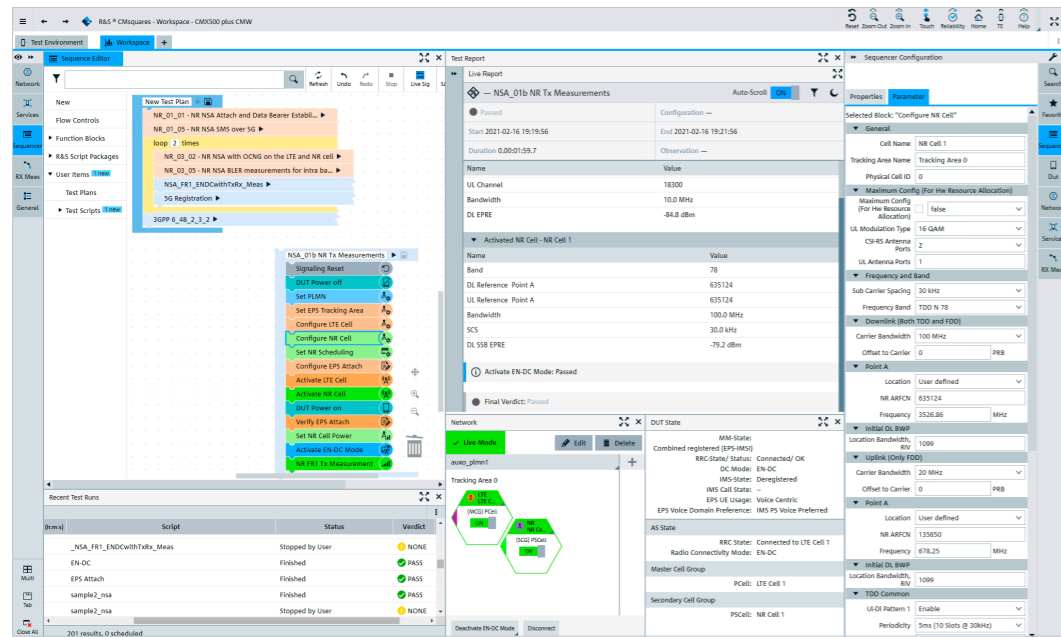

XLAPI PYTHON INTERFACE FOR WRITING REPEATABLE ROUTINES

Python is the most common scripting language and an industry standard for testing and automation frameworks. To configure and control the R&S®CMX500 and verify DUT behavior, Rohde & Schwarz provides the XLAPI Python scripting interface.

The simple and abstract interface enables users to spend their precious time testing rather than programming. For users who want to go deeper into configuration and peer message content, XLAPI also has a flexible configuration mode. Python test script packages created and maintained by Rohde & Schwarz provide a user-friendly starting point for device verification, whether for FR1, FR2, non-stand-alone or standalone modes.

Test campaigns and regression tests with XLAPI test scripts can be created and executed in R&S®CMsequencer. Integration in user automation frameworks is easy, whether via R&S®CMsequencer or Python scripts executed directly from the user framework.

Key facts

- ▶ Self-sufficient installation (no effect on existing Python installations)
- ▶ Configure only what is needed (only necessary parameters are configured, the rest will be adjusted or default values used)
- ▶ Comprehensive help with extensive documentation on version upgrades
- ▶ Any other Python modules can be used
- ▶ Covers all functional tests including RF, throughput, mobility and multi-SIM

The scripts written in the integrated Python development environment can communicate with all device functions.

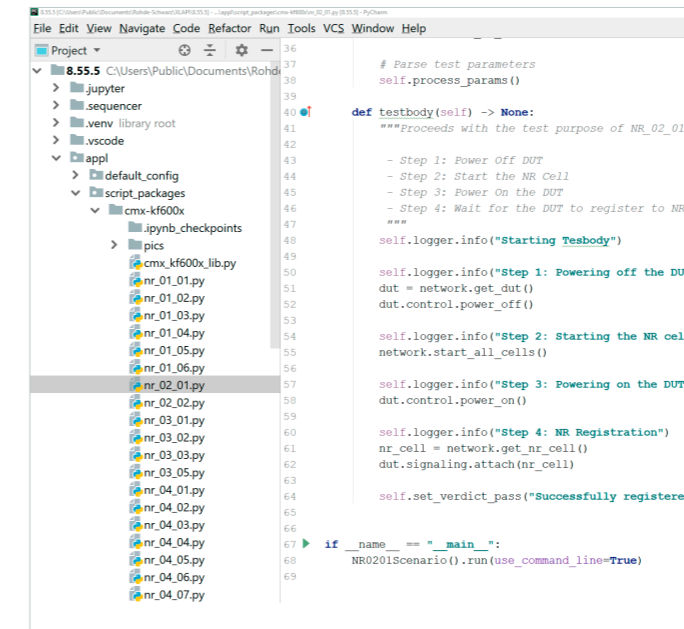

The integrated tutorials and information texts make it easy to use XLAPI.

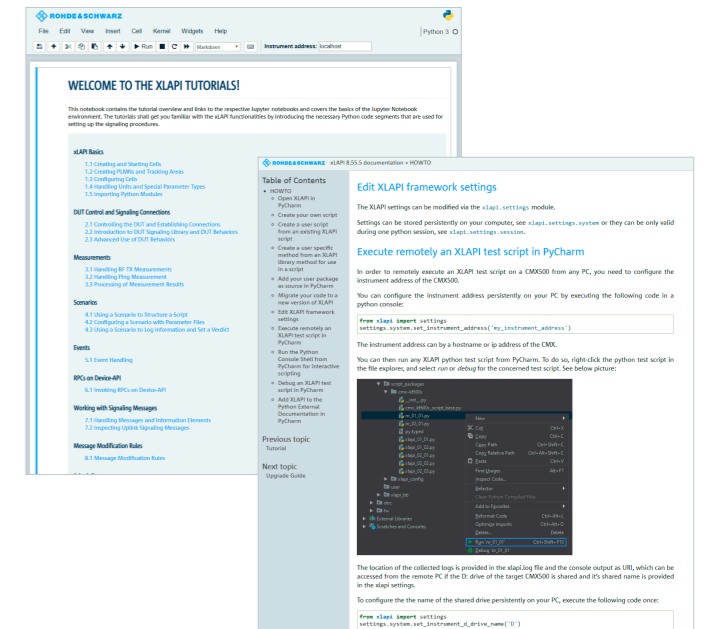

UNIQUE INTEGRATED SOLUTION FOR 5G END-TO-END TESTING

Thanks to the fully integrated IP test environment, the R&S®CMX500 ensures top reproducibility and stability while dramatically shortening configuration and end-to-end test times.

- ▶ Fully integrated IP data test environment for 5G NR FR1 and FR2, standalone (SA) and non-standalone (NSA) testing
- ▶ > 20 Gbps E2E IP data performance
- ▶ Optimized IP servers, measurements and tools to enable 5G E2E IP throughput and latency verification
- ▶ Ready-to-use application servers for testing common internet services, e.g. file transfer, web browsing, IMS services, media streaming
- ▶ Easy configuration in R&S®CMsquares interface or with SCPI and xLAPI scripting

The challenge

While other end-to-end testing setups have several components, we learned early on that external components used as throughput servers or internet gateways generate multiple uncertainties in test results. Many aspects need to be taken into consideration: the physical connection between components and corresponding jitter and delay insertion, the external PC operating system and configuration, firewall settings, etc; all making the configuration complicated. Moreover, when testing at different sites, ensuring identical setups and results is even more challenging.

In the past

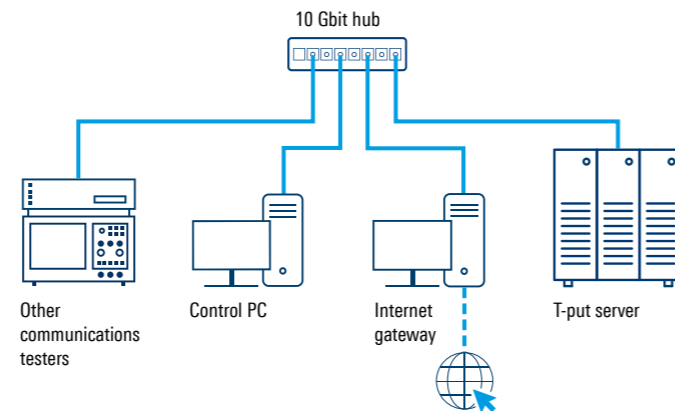

Best reproducibility and stability wherever you need it

The R&S®CMX500 simulates worldwide distributed servers.

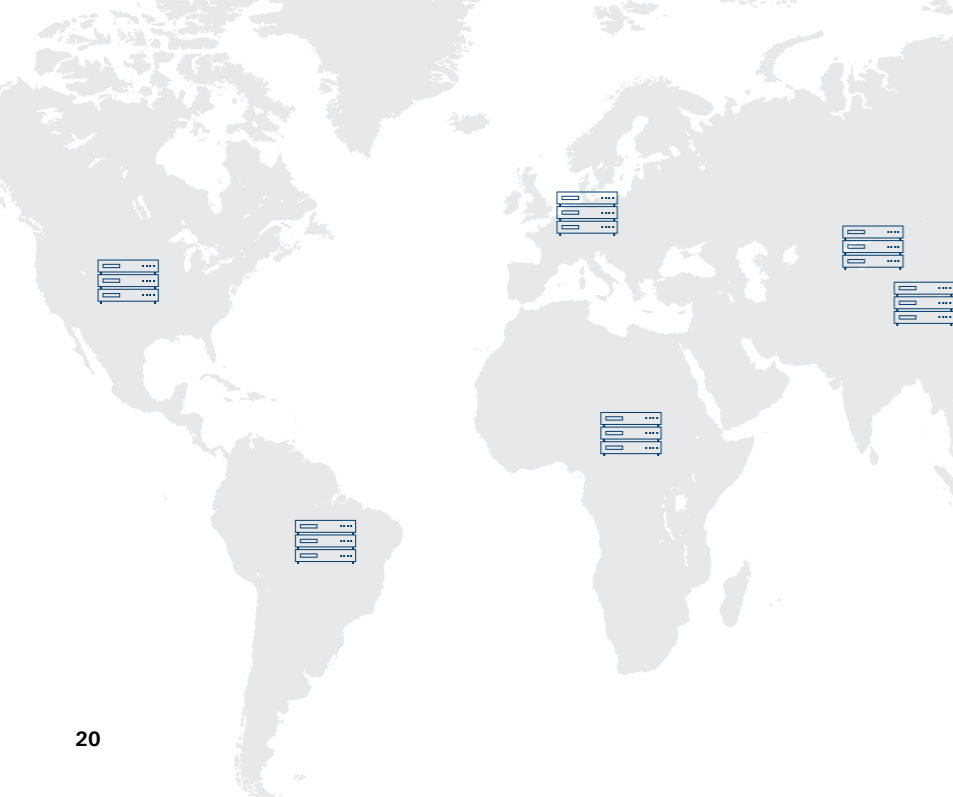

The Rohde & Schwarz solution

We want to provide an accurate, reliable and uniform IP data test environment that simplifies configuration and delivers truly reproducible results. The R&S®CMX500 provides an easy-to-configure and reliable solution for IP application testing. It offers all required servers and tools to test the most common internet protocols (TCP or UDP) out of the box.

Mobile device vendors and network operators can identify error sources early on by accurately measuring IP performance under specific and controlled network conditions. Designed for extreme high data throughput in the 20 Gbps range, the R&S®CMX500 can test even the most demanding 5G applications.

IMS server

The internal IP multimedia subsystem (IMS) server allows the DUT to perform and test voice and video calls as well as SMS over SDP and RTP protocols in IP networks.

DNS server

When testing internet connectivity and over-the-top (OTT) applications, a DNS server is essential for translation.

FTP server

The integrated FTP server enables file uploads and downloads between the DUT and lets the R&S®CMX perform TCP throughput testing via file transfer protocol (FTP).



Streaming server

As part of the built-in web server, the R&S®CMX features a streaming server to easily start and test video streaming on the DUT.

HTTP server

The built-in web server offers a web portal that can be used to test web browsing via hypertext transport protocol (HTTP).

APPLICATION-CENTRIC SIGNALING CONCEPT

The R&S®CMX500 offers Basic, Medium and Xpert signaling, where each of them supports all kind of applications to a certain extent. Maintenance contracts ensure users always have state-of-the-art tests available.

Basic, Medium, Xpert – the easily upgradeable signaling concept

The R&S®CMX500 option concept is fundamentally different from other concepts, which differentiate between signaling for various applications, such as RF and protocol test applications. The R&S®CMX500 focuses on the test applications themselves. Signaling options can be selected based on the test application. The user can choose between three signaling options that build on each other: Basic (B), Medium (M) or Xpert (X) signaling. The last letter in the option name indicates which signaling option has been selected for the application.

Signaling selection examples

3GPP RF test scenarios in the R&S®CMX-KC660B packet only require the basic signaling version. If the signaling requirements become more demanding, the scope can be easily expanded with an option. The scope of the available system parameters increases and with it the test setup flexibility. Xpert level signaling is needed for full access to the signaling messages and the ability to alter them, as required for protocol testing, for example.

Constantly changing test requirements

The world of cellular communications is based on 3GPP specifications and these are constantly changing. A technology such as New Radio (NR) grows through expansion in the sequential releases (Rel. 15, Rel. 16, ...) and these are also constantly being adapted and optimized with change requests within a release version.

To make sure that the applied stack procedures are always in line with the current version of the 3GPP specifications, Rohde&Schwarz offers software maintenance contracts for NR signaling options and NR test case/test scenario packets with open terms.

Always up-to-date with software maintenance contracts

Software maintenance contracts include enhancements to purchased features that ensure compliance. Users who have signed a software maintenance contract with Rohde&Schwarz can run all updates released during the negotiated term, ensuring immediate reaction to specification changes and test set compliance. Rohde&Schwarz offers the following software maintenance contracts:

- ▶ R&S®CMX-PU600 offers software maintenance for NR Basic and Medium level test scenarios
- ▶ R&S®CMX-PU601 offers software maintenance for NR Xpert level test scenarios and test cases
- ▶ R&S®CMX-PU610 offers software maintenance for NR signaling

Committee work

Rohde&Schwarz is actively involved in all relevant standardization committees and forums to further enhance wireless technologies. This helps to ensure that all changes and amendments are quickly included in software updates. Software maintenance contracts are available for stacks (signaling), Xpert level test cases and test scenarios as well as basic and medium level test cases and scenarios. The following changes are integrated here: CRs, changes to the baseline and expansion to the functional scope (within the described properties of the option).

The flexibility gained with a software maintenance contract is important since all mobile devices must fulfil a range of criteria in accredited test houses before they can be sold on the market. This is not only true for GCF and PTCRB tests but also for multiple certification tests with a wide range of network operators. The test criteria are typically updated every three months. Users can perform currently applicable test cases and scenarios within the framework of the software maintenance contract.

Software maintenance contract example



Initial purchase: user buys R&S®CMX500 radio communication tester and signaling options

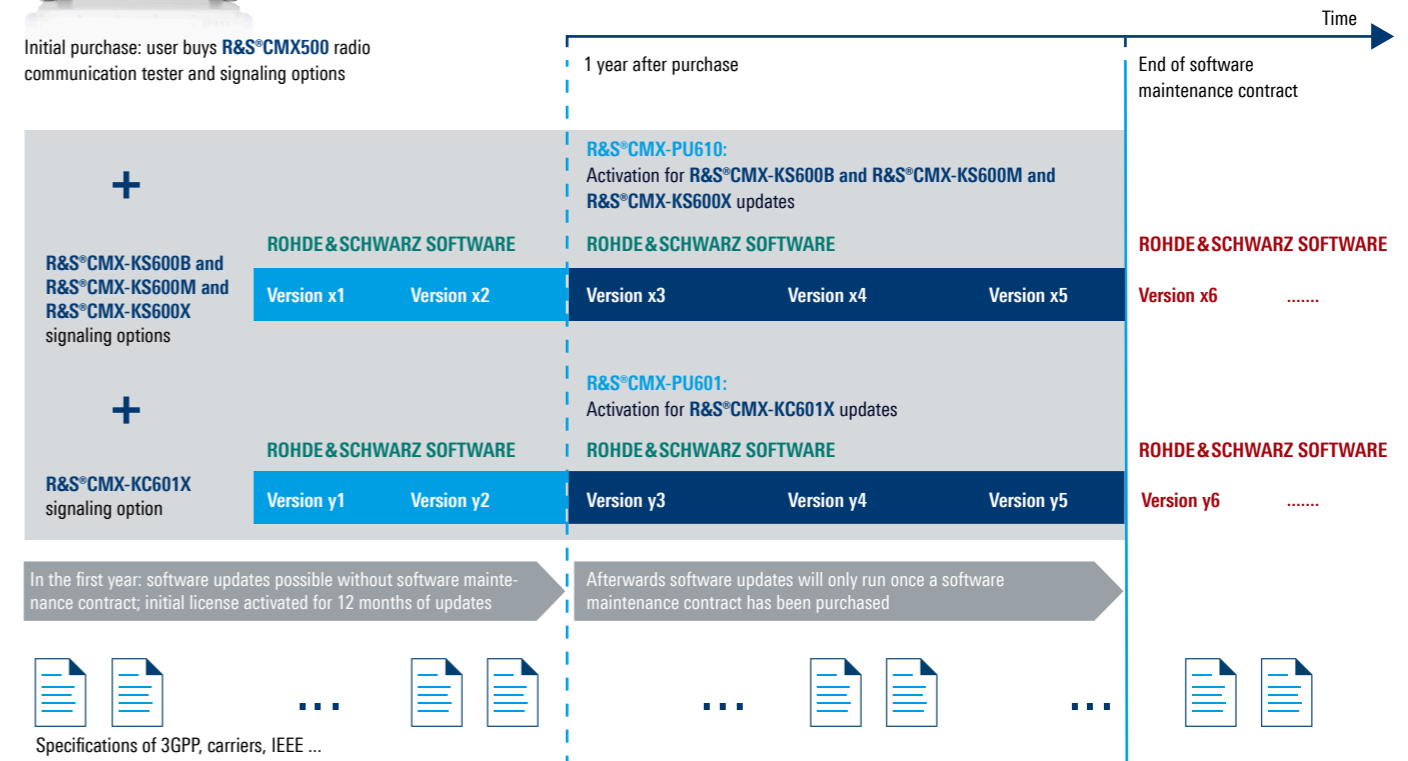

Product structure

The final letter in the test application option name (B, M or X) indicates the required signaling option.

Applications

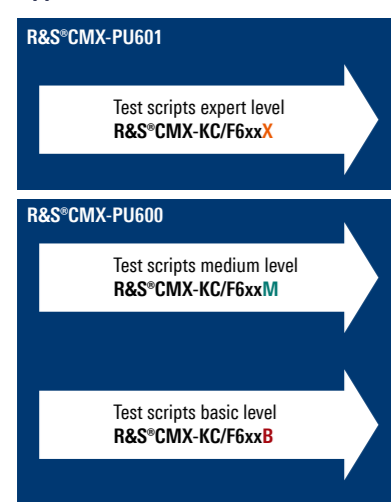

Signaling options



R&S®CMX500 USE CASES

The R&S®CMX500 can perform 5G NR measurements for all use cases of 5G device testing: RF testing, signaling testing, E2E testing, conformance testing and carrier acceptance tests.



RF TESTING

RF measurements or measurements of the transmit and receive characteristics, are the basis for device testing. The R&S®CMX500 offers a user-friendly test solution for lab applications that delivers reliable and reproducible results.

Flexible scheduling

A chipset manufacturer has different RF measurement requirements than a network operator. The R&S®CMX500 with the R&S®CMsquares user interface takes into account the differences between the various applications. Details for many test scenarios can be flexibly and interactively set "on the fly". R&S®CMsquares and the integrated R&S®CMsequencer offer everything needed to successfully perform RF measurements: the necessary flexibility and large predefined libraries. Test solutions needed for specific RF measurements are easy to create. RF measurements are possible in the FR1 and FR2 frequency ranges, in chambers and with remote radio heads (RRH). Users have access to all parameters, can flexibly adjust them and reproduce results at any time.

3GPP test cases

R&S®CMsequencer includes the predefined 3GPP RF TX/RX tests in line with IEEE38.521, which are implemented in the basic signaling options R&S®CMX-KC660B (NSA FR1 3GPP RF test scenarios) and R&S®CMX-KC661B (SA FR1 3GPP RF test scenarios). The scheduling is in line with the standard. The tests work at the press of a button



The R&S®CMX500 can be used as a base station emulator for RF tests.

and users do not need to waste any time with parameter settings. The predefined libraries for FR1 and FR2 can also be modified. Bands, bandwidths, channels, modulation, resource allocation and much more are all adjustable.

Interactive RF tests can be flexibly compiled with R&S®CMsquares. In the screenshot, LTE measurements are to the left and the 5G FR1 measurements on the right can also be created with R&S®CMsequencer.



R&S®CMsequencer Shuffler

The R&S®CMsequencer Shuffler iterates through device MRDC band combinations, providing fully automated DUT health checks.

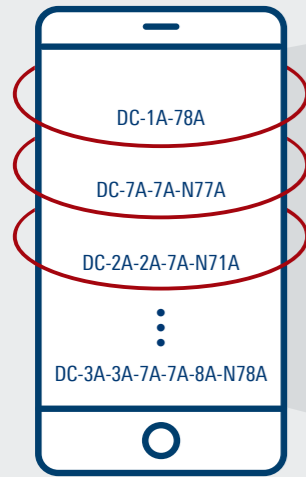

MRDC BandCombination: DC_1A_n7A
▶ Activated LTE Cell - LTE Cell 1
▶ Activated NR Cell - NR Cell 1
① Activate EN-DC Mode: Passed
▶ NR FR1 TX Measurement @NR Band n77; UL: PwrA.AARFCN 450000 (1750.000 MHz); Center Freq. = 1796.140; DC-MODE = EN-DC
① MRDC BandCombination: DC_1A_n7A
▶ Activated LTE Cell - LTE Cell 1
▶ Activated NR Cell - NR Cell 1
① Activate EN-DC Mode: Passed
▶ NR FR1 TX Measurement @NR Band n79; UL: PwrA.AARFCN 713334 (4700.070 MHz); Center Freq. = 4746.150; DC-MODE = EN-DC
① MRDC BandCombination: DC_3A_n7A
▶ Activated LTE Cell - LTE Cell 1
▶ Activated NR Cell - NR Cell 1
① Activate EN-DC Mode: Passed
▶ NR FR1 TX Measurement @NR Band n71; UL: PwrA.AARFCN 115050 (878.250 MHz); Center Freq. = 887.790; DC-MODE = OFF
① MRDC BandCombination: DC_3A_n7A
▶ Activated LTE Cell - LTE Cell 1
▶ Activated NR Cell - NR Cell 1
① Activate EN-DC Mode: Passed
▶ NR FR1 TX Measurement @NR Band n28; UL: PwrA.AARFCN 135500 (878.250 MHz); Center Freq. = 882.830; DC-MODE = OFF

Sophisticated tools

The R&S®CMsequencer campaign manager can execute RF measurement blocks together with 3GPP test cases in a single run. The R&S®CMsequencer Shuffler can extract user equipment capabilities and automatically test all band combinations in a single run. The R&S®CMX500 supports all combination from a single component carrier to 8CC in FR2.

Extendable for mmWave measurements

The standard R&S®CMX500 setup with R&S®CMW500 in the FR1 range can be upgraded into an mmWave setup by adding R&S®CMXHEAD30 remote radio heads and additional internal IF modules (R&S®CMX-B500A).

The R&S®CMXHEAD30 devices up- or downconvert respectively from the IF signal into the required mmWave RF spectrum to support the TX and RX signal at the dual polarized antenna inside the over-the-air (OTA) chamber. Depending on the test requirements, the setup can be connected to one of the Rohde&Schwarz OTA chambers (see Complementary products from Rohde&Schwarz on page 32). For typical RF tests, we recommend the R&S®ATS800R rack based CATR¹⁾ antenna test system with optional positioner.

To boost the output power or increase the signal-to-noise ratio (SNR) or for bandwidth extensions, we offer the R&S®CMX-RF42 RF frontend, an active combiner. In line with 3GPP requirements, EIRP, CDF or TRP measurements can be reliably performed within the OTA chamber.

Easy transfer into production

After the development phase, test requirements can be easily transferred into the production phase with identical SCPI commands. Since the R&S®CMX500 and the R&S®CMP200 radio communication testers are based on the Rohde&Schwarz one-platform strategy, they use the same SCPI command set.

¹⁾ CATR: compact antenna test range.

FR1 and FR2 setup with R&S®CMX500, R&S®CMW500, 2 × R&S®CMXHEAD30 remote radio head and R&S®CMX-RF42 RF frontend for NR FR2. The R&S®ATS800R rack based CATR antenna test system is added for the OTA setup.



The R&S®ATS800R rack based CATR antenna test system together with the R&S®CMX500, R&S®CMW500, 2 × R&S®CMXHEAD30 and R&S®CMX-RF42 is used for the OTA setup.

5G APPLICATION TESTING

5G innovations like virtual reality, online gaming, live event streaming, as well as critical low latency and ultra-reliable applications will transform user experience and industries. To verify E2E data transmission over 5G networks, the R&S®CMX500 offers a the powerful and fully integrated IP data test environment.

Fully integrated IP data testing environment

5G defined as an all-IP communications network will pave the way for numerous new use cases thanks to high data rates and low latency. The R&S®CMX500 offers a fully integrated IP end-to-end test environment and tool chain to ensure the quality of service (QoS) and user experience for most common 5G FR1 and FR2 applications. IPv4/6 configuration, throughput measurements with iPerf and immediately available Web, FTP, DNS and IMS servers enable expansive end device testing at the IP level. All the functions are available in an R&S®CMsquares services square. The reproducibility of the test conditions in this user-friendly data test solution reduces test times and effectively supports delivery of the desired quality of service.

Audio and video testing

In recent years, data services have overtaken voice telephony as the most important source of income for network operators, but voice telephony still accounts for a significant revenue share and cannot be neglected. Voice is the king of communications and in the 5G world it is more important than ever as seen in various use cases. To satisfy the end-user expectations for higher audio and video quality, the R&S®CMX500 has an integrated IMS server for voice over NR (VoNR) and voice over LTE (VoLTE) testing in non-standalone (NSA) and standalone (SA) scenarios in combination with all important codecs. Audio and video functional tests can be performed in loopback mode. An external audio analyzer enables 5G audio quality analysis over both, analog and IP interfaces.

IP servers and tools in R&S®CMsquares.

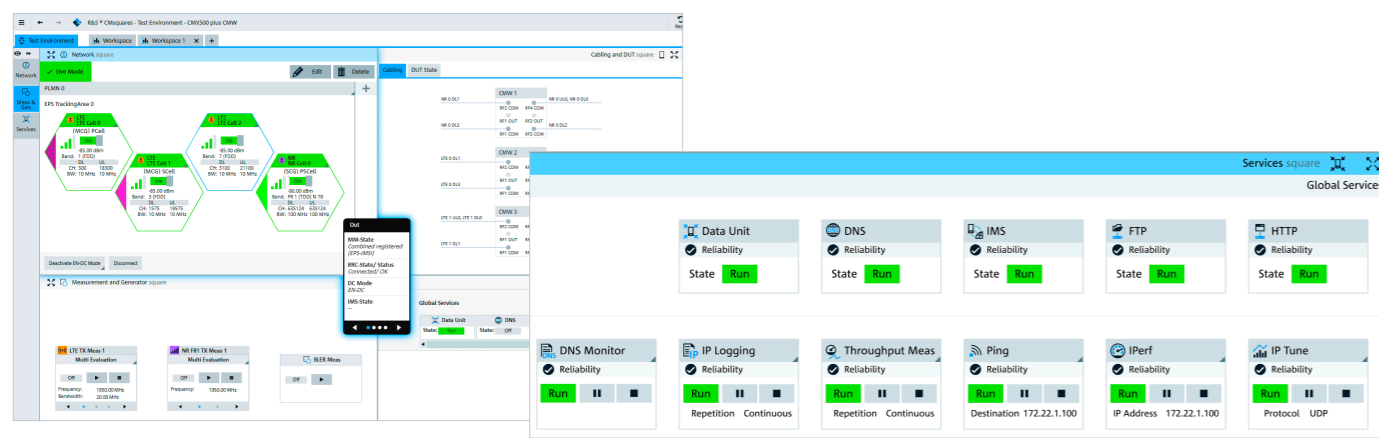

Maximum flexibility in 5G audio quality analysis

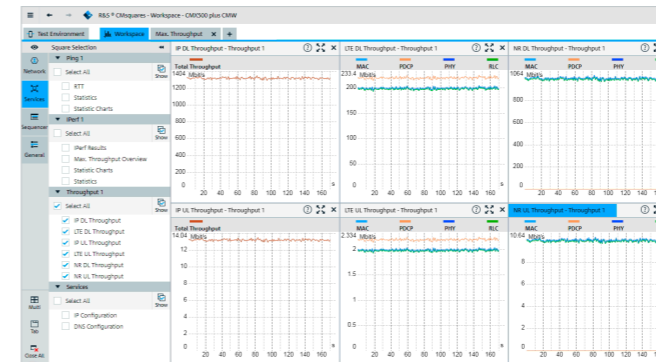
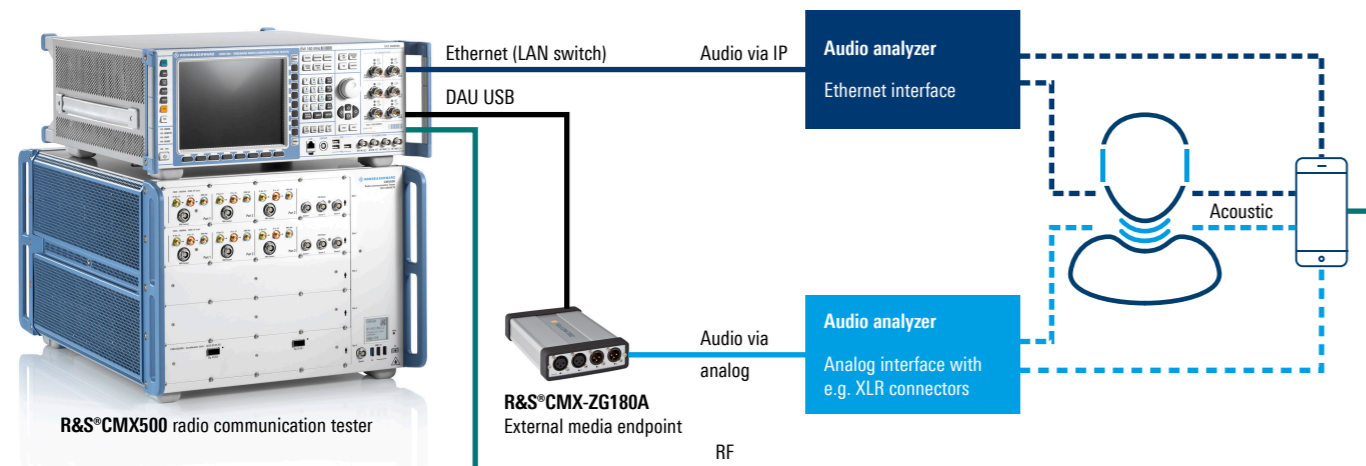

5G throughput measurements over multiple layers.

Throughput testing

Network operators rely on 5G to accelerate networks and satisfy smartphone users and other verticals. To meet the data rate expectations, complex test scenarios are needed. Maximum throughput testing is more challenging than in the past because of the multiple network configurations and new signaling parameters in 5G. Designed for more than 20 Gbps data performance, the R&S®CMX500 offers a unique test environment to simplify throughput test configuration and analysis. Powerful IP tools such as the maximum TP wizard, enable users to reach maximum data rates in just a few clicks. Dedicated IP measurements provide a comprehensive overview of traffic along the different layers. Traffic bottlenecks can be immediately identified and addressed.

Battery life testing

5G enables new possibilities to end users and verticals, but it also brings big power consumption challenges. High performance applications such as gaming or virtual reality drain batteries. From the RF perspective, NSA scenarios with two radio technologies running in parallel will considerably increase power consumption in devices. Given battery life is an important factor for end users, device manufacturers are working constantly to optimize energy consumption. Dedicated power saving features are also defined for 5G networks. To seamlessly monitor the power consumption of a device running different RF, protocol and application testing scenarios in parallel, the R&S®CMX500 integrates power measurements from the R&S®NGM200 power supply series and displays the results in R&S®CMsquares, in keeping with the concept of performing all measurements in one place.



5G THROUGHPUT TESTING

The R&S®CMX500 allows traffic generation and monitoring of 5G high data rates along with the different layers, including the physical and IP layers.



AUDIO AND VIDEO TESTING

The integrated IMS server enables voice, video and SMS testing over NR and LTE.

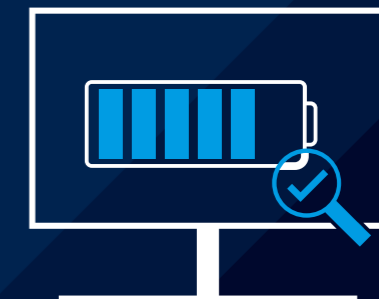

BATTERY LIFE TESTING

The seamless integration of power consumption measurements for unique insights combined with RF, protocol and application tests.

CARRIER ACCEPTANCE TESTS AND CERTIFICATIONS

R&S®CONTEST test system software complements R&S®CMsquares for carrier acceptance tests and certifications.

Test scenarios for network operators

The many possibilities to design a 5G network (FR1, FR2, NSA, SA, etc.) and to offer services create countless functional cross connections and dependencies. These may differ from network to network or be country-specific, which is why network operators create extensive independent test plans that cover their specific needs. These are carrier acceptance tests.

The R&S®CMX500 with the R&S®CMsquares test environment and R&S®CONTEST test system software is ideal for performing carrier acceptance tests. R&S®CONTEST functions include non-typical tests such as voice over NR (VoNR), the US emergency call service E911, location based services (LBS), rich communications

services (RCS, such as group chat, enriched calling, file sharing) and data throughput measurements with various MIMO configurations.

R&S®CONTEST test system software

R&S®CONTEST is a test system software with versatile automated test properties, satisfying both the special needs of network operator test scenarios and conformance testing in line with 3GPP. R&S®CONTEST enables fully automated test procedures and offers comprehensive analysis capabilities for evaluating tests and summarizes these tests in easy-to-understand reports, while also offering many useful tools. The drag-and-drop function compiles the desired test cases into a test plan in the R&S®CONTEST interface.

Performing carrier acceptance tests with R&S®CONTEST test software: R&S®CONTEST enables fully automated performance of test cases and provides extensive summary reports along with powerful analysis tools to evaluate test reports.

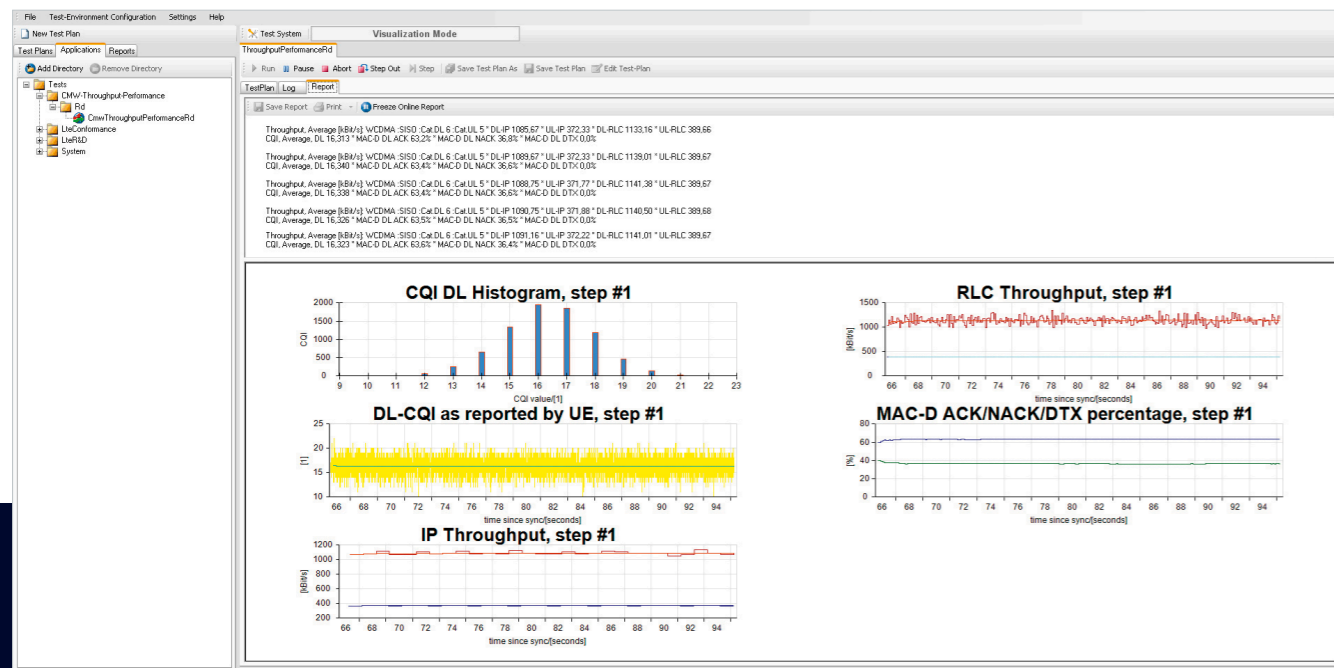

Many test case parameters such as frequencies or signaling settings can be graphically edited and new test steps added. The test object and its cabling can be easily described and then taken into account during automatic calibration. User-friendly remote access to the test system is also available and the current status of the test sequence is displayed on a web browser.

3GPP certification

R&S®CONTEST supports certification tests in line with GCF and PTCRB on various platform configurations – from compact and cost-efficient solutions for LBS, RF, RRM and protocol conformance tests with an R&S®CMW500 and R&S®CMX500 to standalone R&S®TS-RRM and R&S®TS8980FTA RF test systems with out-of-band capability.

The R&S®TS8980FTA-3A is a unique test solution for all radio access technologies from GSA, WCDMA, LTE to 5G, and is a well-established tool for reliable RF conformance testing. The integrated test system running on R&S®CONTEST test system software delivers efficient, precise and reproducible measurement results.

The R&S®TS8980FTA-3A test system together with the R&S®ATS1800C CATR based compact 5G NR mmWave test chamber.



COMPLEMENTARY PRODUCTS FROM ROHDE & SCHWARZ

Rohde & Schwarz offers system components for 5G NR signaling testing in the FR2 frequency range. In addition to the R&S®CMX500, these include antennas, cables, feedthroughs, power sensors, shielding chambers, antenna test systems and remote radio heads. Rohde & Schwarz manufactures all system components in own plants, ensuring optimal system parameters. The following provides you with a detailed overview of four of these complementary products. See the Rohde & Schwarz website for other products.

R&S®CMXHEAD30 REMOTE RADIO HEAD



R&S®CMXHEAD30 remote radio head.

R&S®CMXHEAD30 remote radio head is an upconverter and down-converter for 5G FR2 frequencies to verify RX and TX measurements. The R&S®CMX500 can generate and analyze IF frequencies directly at the output. In higher frequency ranges, the R&S®CMXHEAD30 seamlessly takes over. The remote radio head concept allows short RF cable lengths for an optimal link budget in radiated test environments for testing fully assembled FR2 devices and RFICs with both IF and mmWave RF interfaces. The multiband R&S®CMXHEAD30 covers all important FR2 bands.

R&S®CMQ500 SHIELDING CUBE

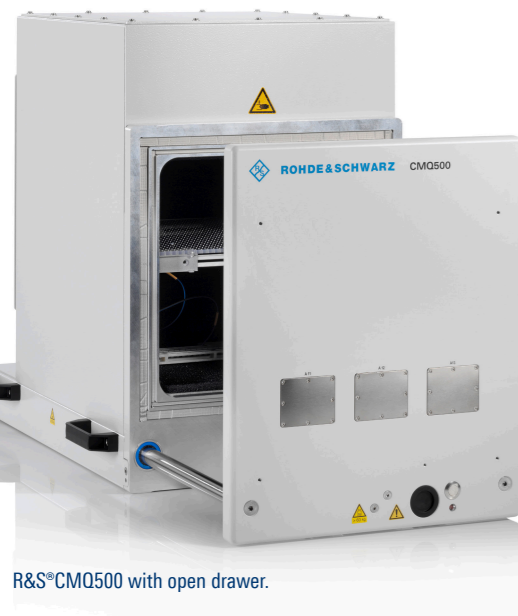

R&S®CMQ500 with open drawer.

The R&S®CMQ500 shielding cube is a compact and fully integrated solution that covers most 5G devices in various applications. The robust mechanical design ensures reliable measurements in R&D environments. The flexible cube design covers applications for smart devices, CPEs, RFIC and prototypes. The R&S®CMQ500 is ready for 5G and other technologies in the frequency range from 0.7 GHz to 77 GHz. The R&S®CMQ500 can easily be scaled for different DUT sizes and requirements. Small antennas make it easy to test relatively large DUTs in the compact shielding cube. Flexible mounts allow antennas and probes to be mounted and aligned in any position. The mounts have a swivel head to cover various quiet zones.

R&S®ATS800R RACK BASED CATR ANTENNA TEST SYSTEM



R&S®ATS800R with the R&S®CMX500 and the R&S®CMW500 wideband radio communication tester.

The R&S®ATS800R rack based CATR¹⁾ antenna test system is a very compact environment for 5G antenna, module and device characterization in the frequency range from 20 GHz to 50 GHz. It is an essential tool in R&D design verification for both active and passive devices. It has a gold-plated parabolic CATR reflector with rolled edges and a feed antenna. The DUT is placed on the device fixture on the bottom of the anechoic chamber for easy testing. The device fixture allows for flexible DUT mounting inside the 20 cm high quality quiet zone. This can be done using pin holes or threaded holes that match the mechanical interface of the Rohde & Schwarz calibration antennas. In combination with the R&S®CMX500, it ensures fast and smooth characterization in the mmWave frequency range. The R&S®ATS800R can be expanded with a 3D positioner or a climate option for extreme temperature tests.

¹⁾ CATR: compact antenna test range.

R&S®ATS1800C CATR BASED COMPACT 5G NR mmWAVE TEST CHAMBER



R&S®ATS1800C.

The R&S®ATS1800C CATR based compact 5G NR mmWave test chamber is a turnkey chamber for far-field OTA RF measurements of 5G devices and components in the frequency range from 6 GHz to 90 GHz. The chamber itself is easily transportable with wheels and has a footprint small enough to pass through most doors, so it easily fits into R&D labs or test houses of all sizes. Inside the fully shielded chamber is the compact antenna test range (CATR) consisting of a feed antenna, a bidirectional parabolic reflector and a 3D positioner. The parabolic reflector is specially designed and manufactured with optimized rolled edges for well distributed collimated beam power after reflection. Moreover, the reflector has extremely high-precision surface roughness to minimize errors introduced by the reflection. This allows the reflector to be used in a very wide frequency range for accurate measurement results.

ORDERING INFORMATION



ООО «4TECT»
Телефон: +7 (499) 685-4444
info@4test.ru
www.4test.ru

Designation	Type	Order No.
Base unit		
Radio communication tester; instrument with following accessories: power cords, operating manual (getting started), R&S®CMX-B300A cables, R&S®CMX-PB70B cables	R&S®CMX500	1201.0002K70
Hardware options		
R&S®CMX500 basic assembly	R&S®CMX-PB70H	1222.0676.09
R&S®CMX500 accelerator unit	R&S®CMX-B200A	1222.0747.02
R&S®CMX500 processing unit	R&S®CMX-B300B	1222.0801.03
R&S®CMX500 IF unit	R&S®CMX-B500A	1222.0924.02
Software options		
NR signaling, NSA mode enabler Basic level, 2x2 MIMO and 4x4 DL (one CC only), 256QAM UL	R&S®CMX-KS600B	1222.1672.02
NR signaling, NSA mode enabler Medium level, 2x2 MIMO and 4x4 DL (one CC only), 256QAM UL	R&S®CMX-KS600M	1222.1650.02
NR signaling, NSA mode enabler Xpert level, 2x2 MIMO and 4x4 DL (one CC only), 256QAM UL	R&S®CMX-KS600X	1222.1695.02
NR signaling, SA mode enabler Basic level, 2x2 MIMO and 4x4 DL (one CC only), 256QAM UL	R&S®CMX-KS601B	1222.2327.02
NR signaling, SA mode enabler Medium level, 2x2 MIMO and 4x4 DL (one CC only), 256QAM UL	R&S®CMX-KS601M	1222.2333.02
NR signaling, SA mode enabler Xpert level, 2x2 MIMO and 4x4 DL (one CC only), 256QAM UL	R&S®CMX-KS601X	1222.2340.02
NR SIG extension Basic, UL 2x2 MIMO, CA up to 8CC	R&S®CMX-KS610B	1222.3700.02
NR SIG extension Medium, UL 2x2 MIMO, CA up to 8CC	R&S®CMX-KS610M	1222.3717.02
NR SIG extension Xpert, UL 2x2 MIMO, CA up to 8CC	R&S®CMX-KS610X	1222.3723.02
R&S®CMX500 application test featureset 1 (SL)	R&S®CMX-KA100	1222.1595.02
R&S®CMX500 IP traffic analysis (SL)	R&S®CMX-KA150	1222.4159.02
Remote radio heads (RRH)		
Remote radio head	R&S®CMXHEAD30	1201.0002K73
R&S®CMXHEAD30 hardware unit	R&S®CMXH-B73A	1430.9106.02
Remote radio head connection cable, length: 3 m	R&S®CM-Z30A	1212.1040.02
Extras		
5G NR UICC test SIM	R&S®CMX-Z01	1222.3917.02
Monitor mount	R&S®CMX-Z101A	1222.3098.02
R&S®CMX500 transport case	R&S®CMX-ZG501A	1222.3075.02

SOFTWARE MAINTENANCE CONTRACTS

Designation	Type	Order No.
Software maintenance for NR Basic and Medium level test scenarios	R&S®CMX-PU600	1222.4036.81
Software maintenance for NR Xpert level test scenarios and test cases	R&S®CMX-PU601	1222.4042.81
Software maintenance for NR signaling	R&S®CMX-PU610	1222.4059.81